

UNDERGROUND METAL DETECTOR

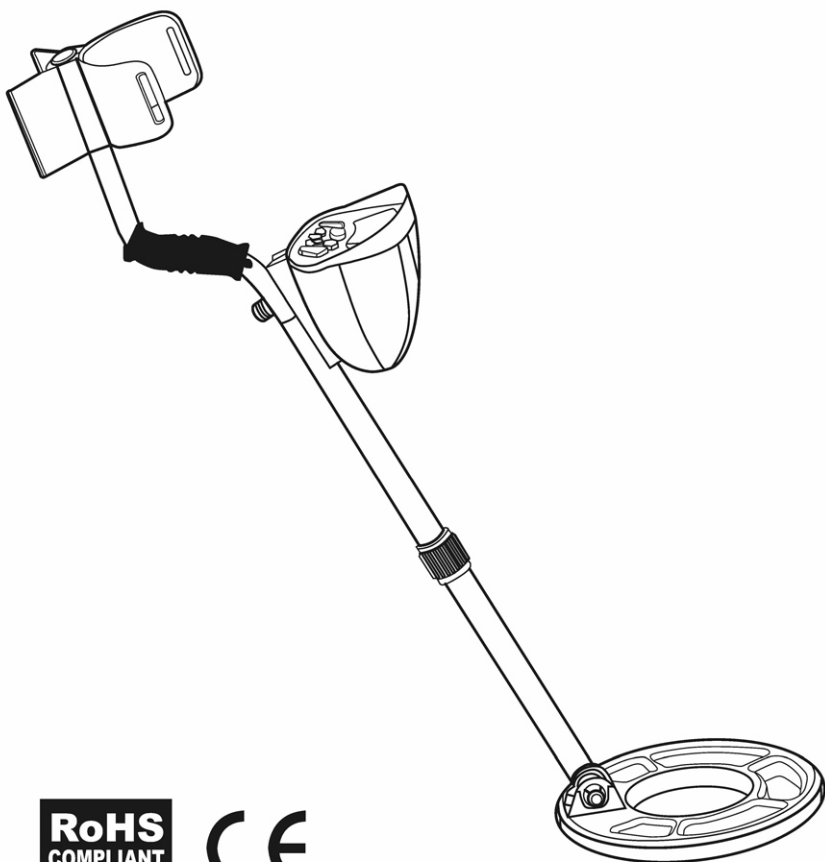

RoHS
COMPLIANT
2002/95/EC



CONTENT

1. INTRODUCTION

1.1 FEATURES OF YOUR DETECTOR

2. PARTS AND NAMES

3. PREPARATION

3.1 ASSEMBLING THE DETECTOR

3.2 INSTALLING BATTERIES

3.3 BATTERY CONDITION INDICATION

3.4 USING A HEADPHONE

4. OPERATION

4.1 CONTROL PANEL

4.2 LCD DISPLAY

4.3 OPERATION INSTRUCTION

4.4 SEARCH TESTING

4.5 OPERATION TIPS

4.6 METAL DETECTOR OPERATORS ETHICS

4.7 PLACES WHERE YOU CAN USE YOUR METAL DETECTOR

5. MAINTENANCE

6. SPECIFICATION

1. INTRODUCTION

Thank you for purchasing our metal Detector. With this powerful and versatile device, you can hunt for coins, relics, jewelry, gold, and silver just about anywhere. To obtain maximum performance, The detector is versatile and easy to use with LCD. We urge you to take a few minutes to read this manual carefully and retain this manual for future reference.

FEATURES OF YOUR DETECTOR

Fully Automatic and All Metal Detectors - Your detector detects all kinds of metal objects. Unless you have set for some objects that you don't want to detect.

LCD – The LCD , it improve to identify the metal in night or caliginous outside. Use a new display mode with patented technology. Additional automatic BG color adjusting system to further insure the LED works better in function of resolution ratio during day and night. More importantly save power. The BG color can be ordered from white .

Display- The object responses in a more direct pointing way on the screen with three different sound frequency classifying the different kinds of metals. position targeting: the signal on the screen will flashing toward the middle when approaching the object.

Panel surface abrasion resistance - the panel is made of a material with surface abrasion resistance that ensures the LED well works.

High brightness LED flashlight- Additional flash holder for night searching, use high brightness LED flashlight

Mode-Mode 1 (factory default) is set up originally for low speed researching when you switch on, to speed up press Mode button. this fast researching mode may reduce detection accuracy.

Target Identity- The detected objects are shown on the LCD display. You can decide immediately if the objects worth to be recovered.

Unwanted Target Elimination - You can set the detector not to respond to some objects.

Unique Tone for Target - You don't have to keep watching the LCD display, when an object is being detected, an unique tone corresponding to a target will generate. You may even searching when there is little or no light.

No Clumsy Slack Cable - hidden search coil cable (connecting between control unit and search coil) avoid entangling and for ease of stem length adjustment.

Speaker- use water-proof loudspeaker.

Headphone Jack - provided for headphone connection. Both stereo or mono headphone can be used.

Volume Control - for adjusting the output volume to the loud speaker or headphone.

Batteries Condition Indicator - shows the conditions of the batteries in the battery compartment.

Waterproof Search Coil - lets you use the detector in the shallow water.

Adjustable Stem - lets you adjust the detector's length for comfortable use. The micro-plug that connects the search coil and the controller unit is made of metal which makes the plug more reliable.

Armrest & stem - extra thickened handle and the red and black color brings a direct visual effects. designed to eliminate strain on forearm. armrest belt made of nylon to further strength the detector stay hold.

Power - Use six 1.5-volt AA alkaline batteries.

2. PARTS AND NAMES

NOMENCLATURES:

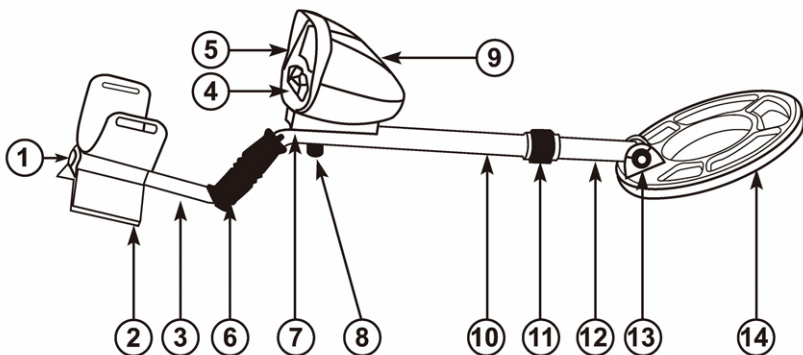

1. SEALING
2. ARMREST
3. ARMREST STEM
4. ADJUSTMENT
5. CONTROL PANEL
6. HANDLERY COMPARTMENT
7. CONTROLLER UNIT

8. KNOB NUT
9. MAIN ENGINE
10. UPPER STEM
11. STEMLOCK NUT
12. LOWER STEM
13. SEARCH COIL KNOBS
14. SEARCH COIL ASSEMBLY

3. PREPARATION

3.1 ASSEMBLING THE DETECTOR

You don't need any special tools to assemble your metal detector. All you need is a small Philips-head screw driver. After unpack your detector, you may start the following assembling and adjustment:

3.1.1 Rotate the STEM LOCK NUT (11) Clockwise until loosens.

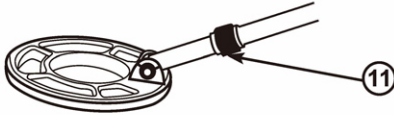

3.1.2 Slide the UPPER STEM (12) towards the SEARCH COIL (14) as indicated by an arrow until you can see a micro-plug metal connector. Pull out the plug so that you can hold it on your hand.

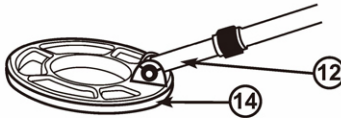

3.1.3 Locate the micro-jack connector in the HANDLE ASSEMBLY (6). Connect the plug and the jack together and care of alignment marks showing on the surface of the jack and plug.

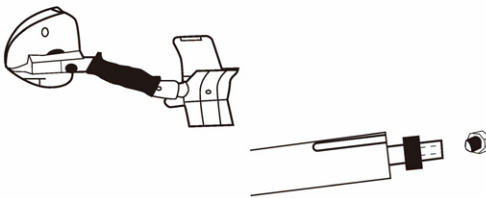

3.1.4 Slide the UPPER STEM (10) towards to the CONTROLLER UNIT. Care should be taken for the direction of the cut slot (of the upper stem) which should be pull underneath the support of the controller unit.

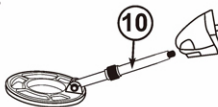

3.1.5 Tighten the KNOB NUT which is located under the CONTROLLER UNIT (7).

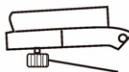

3.1.6 Adjust the LOWER STEM (12) so that when you stand upright with the detector in your hand, the SEARCH COIL (14) is level with and about 1/2 to 2 inches above the ground with your arm relaxed at your side.



3.1.7 Tighten the STEM LOCK NUT (8) in reverse direction (counterclockwise) to lock it in place.

3.1.8 Loosen the SEARCH COIL KNOBS (13) at the SEARCH COIL ASSEMBLY (14), then adjust the search coil to the desired angle. (The Search Coil should be parallel with the ground.) Tighten the knobs just enough to keep the search coil from rotating or wobbling.

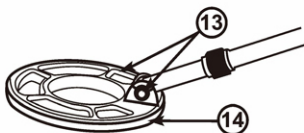

3.1.9 Loosen the 1 screws at the bottom of the ARMREST. Adjust the armrest so that it should be near to the end of your forearm. Tighten the 1 screws in the reverse direction.

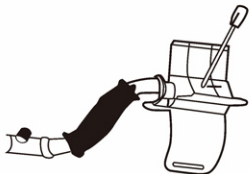

3.2 INSTALLING BATTERIES

You need 6 1.5V AA alkaline batteries to power your detector.

3.2. Press the POWER button on the control panel to make sure that the detector is OFF

3.2.2 Slide the battery cover away from the BATTERY COMPARTMENT (9).



3.2.3 Insert 6 new batteries into the BATTERY COMPARTMENT. Care should be taken for the polarities symbols (+ and -) which are marked on the connection terminals of the detector and the batteries. The polarities of the battery must be matched with the polarities of the terminals.



3.2.4 Replace the battery cover.

Cautions:

- Use only fresh batteries and always replace the old batteries by fresh batteries.
- Do not mix old and new batteries, different types of batteries (standard, alkaline, or rechargeable), or rechargeable batteries of different capacities.
- Never attempt to recharge the non-rechargeable battery. PP3 9-volt battery is normally non-rechargeable.
- Dispose old batteries promptly and properly.

3.3 BATTERY CONDITION INDICATION

The condition of batteries is indicated by the battery icon on the LCD.



The icon starts with 4 segments which indicate the batteries are new and in good condition.

When the icon has only one segment left and flashing, it is the time to replace both batteries.

3.4 USING A HEADPHONE

You should always use a headphone whenever you search with your metal detector. Headphone is especially useful in noisy area, such as the beach and near city area. It enhances audio perception by bringing the sound directly to your ears while masking outside noise interference. You shall be amazed at how much better you can hear the detector signals with the headphone than you can with the speaker alone. Using headphones also save battery power.

To connect a headphone to the detector, insert the headphone's 1/8 inch plug into the HEADPHONE JACK.



Note:

The detector's internal speaker will be disconnected when you connect a headphone.

4. OPERATION

4.1 CONTROL PANEL

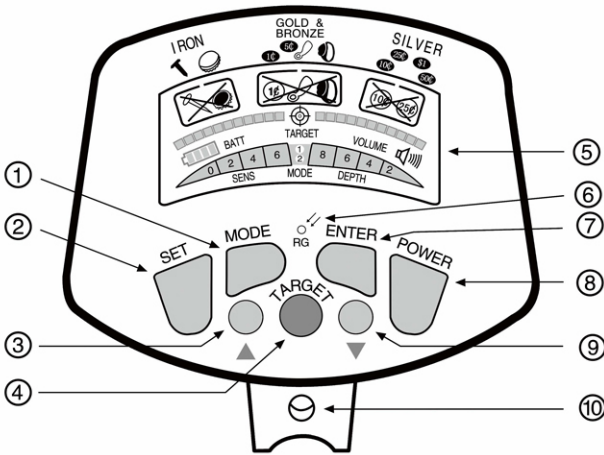

- | | |
|---------------|-------------------------|
| 1.MODE | 6.PHOTOSENSITIVE DEVICE |
| 2.SET | 7.ENTER |
| 3.MOVETOTHE | 8.POWER |
| 4.P/P(target) | 9.MOVETOTHE |
| 5.LCD | 10.PHONE |

POWER: control power ON or OFF

▲: Move to the right position

▼: Move to the left position

MODE: Selects to ignore a target (eliminates a target)

SET: Selects a function

LCD DISPLAY

4.2 LCD DISPLAY

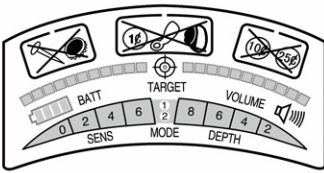

4.2.1. Settable Icons

1. Sensitivity: 4 levels available for sensitivity adjustment.

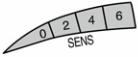

2. Depth: 4 levels available for depth display.



3. Highlight a Target: A rectangular box encircling a target icon flashes when target is selected or being detected.



4. Target Eliminate Indicator: indicates the target that you don't want to detect.



5. Target Icons: To show each icons when you choose.



6. Tone Volume: there are 4 levels of tone volume



7. Target: cooperate with the P/P button to search target.



8. Target precision: full display when approaching target



9. Battery Condition Indicator



10. Mode 1 (factory default) is set up originally for low speed researching when you switch on, to speed up press Mode button. this fast researching mode may reduce detection accuracy.

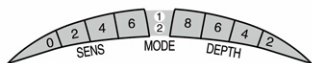

4.3 OPERATION INSTRUCTION

4.3.1 Normal Operation State

- Turn on the detector by pressing on the POWER button once.
- The SENS and DEPTH icons (with other icons) should appear on the display.
- The detector enters in the Normal Operation State.
- Press the POWER again will turn off the power supply to the detector.

4.3.2 Batteries Condition Indicator

- Indicates the conditions of the batteries in the battery box. There are 4 levels or segments.
- All 4 segments appeared indicates the batteries are in good condition.
- One segment is the minimum power at which the device can be operated. When the indicator reaches this level and is flashing, it is time for replacing batteries.

4.3.2 Sensitivity Adjustment

- In the Normal Operating State (Ref to 4.3.1), press on the SET button The SENS icon is flashing.
- Use the ▲ or ▼ buttons to increase or decrease the sensitivity.
- Press the ENTER to confirm the setting and return to the normal Operating State.

NOTE: There are 4 steps or segments of sensitivity level. The more segments displayed, the higher the sensitivity level. High level of sensitivity should always be used for searching since high level of sensitivity can detect deepest and smallest targets, however at high level of sensitivity you will face the problem of False Signal (refer to 4.4.5) which prevent you from setting higher sensitivity. A False Signal occurs when something shouldn't sound like a good target. This is caused by highly mineralized ground or interference from power lines, radio station, etc. As a general rule, reduce sensitivity to prevent excessive false signal.

4.3.3 Targets Eliminate Setting

- In the Normal Operating State, press the SET button (twice) until the highlight icon is flashing. The ferrous nail encircled by the highlight icon means that it is selected.
- Press the MODE button. A "X" mark which denotes "eliminate" will be put on the selected target.
- Use the ▲ or ▼ buttons to select the targets that you don't want the detector to respond.

- Press the MODE button again, the “X” mark will be removed and the target is restored.
- Repeat the above procedures for setting the other targets.
- Press the ENTER to confirm the setting and return to the Normal Operation State.

4.3.4 Target precision

To find the exact locate of the target, press and hold the target button, the audio tone shall be raise loudly when approaching the target, and the screen will be fleshing full set when the exact locate is confirmed.

4.3.5 Tone Loudness Setting

- In the Normal Operating State, Press the SET button (3 times) until the Tone Volume Icon flashing.
- Use the ▲ or ▼ buttons to increase or decrease the tone volume loudness.
NOTE: There are 4 levels or segments of volume.
- Press the ENTER to confirm the setting and return to the Normal Operating State.

4.3.6 Factory Setting

To restore to the factory settings, pressing simultaneously the ENTER and POWER buttons, the detector will resume to the original factory settings.

4.4 SEARCH TESTING

To familiar and learn how the detector reacts to different metals, you should test it before you use it in the first time. You can test the detector indoor and outdoor.

4.4.1 Indoor Testing

- Turn on the detector and make sure that the detector is in the Normal Operating State.
- Place the detector on a table and remove any metal objects including watches, rings or jewelry that you are wearing.
- Adjust the search coil so that the searching face points towards to the ceiling.
- Slowly sweep a sample of the target that you want the detector to find at about 2-3 inches above the face of the search coil. The detector produces a tone for the target.
- Repeat with an eliminated target, e.g.a pull-tab
- Sweep the pull-tab above the face of the search coil. You should note that the detector doesn't respond to the eliminated target

4.4.2 Outdoor testing

- Turn on the detector and make sure that the detector is in the normal operating state.

- Find an area on the ground outside where there are no metal objects.
- Bury few samples at a separation distance of 1-2 feet apart as targets for the testing.
- While holding the search coil level to the ground about 1-2 inches above the surface, slowly move the search coil over the area where you placed the samples, sweeping the search coil in a side-to-side motion.

When a sample is being detected, a tone will be generated.

Slowly lifting up the search coil, the depth indicator on the LCD display increases. This means that the target is a real one. Return to the original position to read the depth level of the target.

Note: The indicator reading is for reference only. The exact depth of a target depends on the projection area on the search coil

4.5 OPERATION TIPS

4.5.1 Objects not on the list

- If the highlight indicator jumping from one target icon to another or vice versa while an object is being detected, the detected object may be an object not in the display list or the soil is highly mineralized. The latter one can be ruled out by decreasing the sensitivity level and search again.

4.5.2 False Signal

The detector is extremely sensitive and will find very deeply-buried object. Because of this, trash-induced signals and other sources of interference might cause signals that seem confusing. The key to handling these types of signals is to dig for only those targets that emit a strong, repeatable signal. As you sweep the ground, learn to recognize the difference between signals that occur at random and signals that are stable and repeatable.

To reduce false signals when searching in very trashy ground, scan only a small area at a time using slow, short overlapping sweeps.

according to your problem, the false signal that the detector indicated might be caused by strong magnetic or mineralized soil. To be certain with the target, we suggest to work on target position, search to prevent the signal disturbing of magnetic or mineralized soil.

4.5.3 Searching Coil Sweeping

- Keep the search coil moving at a comfortable rate. **TAKE YOUR TIME.** If you walk too fast you can't overlap your sweeps and you'll miss a lot of ground. Also if you sweep too fast, you'll lose sensitivity and miss the target.

Keep the search coil parallel to and as close to the ground as practical. This is important for maximum coverage and depth. If you're hunting on a lawn you can rub the coil right on the grass.

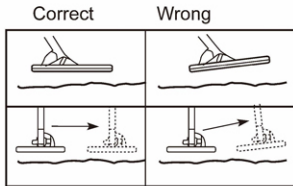

Overlap you sweeps approximately 50%.

- Search in a methodical manner sweeping in a tight semicircle. Pay close attention to where you're going and where you've been .

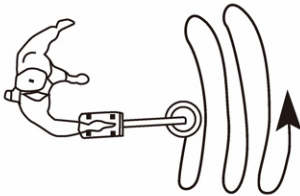

4.6 METAL DETECTOR OPERATORS ETHICS.

Below are few basic rules you should follow while using your metal detector.

Always get permission to hunt on private property

- Always leave a site cleaner than you found it. Take at least some trash with your or, if you can, take it all.
- Always fill in your holes neatly whether you're in a city part or remote wilderness. Leave the land as it was before you disturbed it
- Always obey all laws relating to Treasure Hunting.
- Always return valuable property if you can locate the original owner.
- Always to what ever you can to give the hobby of Treasure Hunting the good image it needs and deserves.

4.7 PLACES WHERE YOU CAN USE YOUR METAL DETECTOR.

- National Forest and Federal lands, State part and lands.
- Corps of engineers, Lakes, shorelines and lands.
- Because of Land Management (BLM) Lands.
- City or country park lands and public school grounds.

5. MAINTENANCE

Your detector doesn't require a lot of care, but where are few things you should do to keep

it in operating condition.

-if you're not going to use it for while, take the batteries out.

-avoid extreme temperature like inside a closed car sitting in the sun.

-if you "scrub" the search coil on the ground, you'll eventually wear off the bottom. Coil replacement are expensive. Instead, invest in an inexpensive coil cover(or called the skid plate.

-put a rain-rest cover over the control housing if you're hunting in rain, fog or dust.

-keep your detector dry and clean. Wipe off the lower stem before sliding into the upper stem and keep the lock nut treads free of sand and dirt.

6. SPECIFICATION

1.BATTERY: 6X1.5V AA alkaline batteries

2.OPERATING CURRENT: STANDBY~40mA (LCD with BG color 80mA)
MAX ~110mA (LCD with BG color 150mA)

3.OPERATING VOLTAGE RANGE:7.2 ~9.6V

4.OPERATING FREQUENCY:7.5KHZ+/-1KHZ

5.SENSITIVITY: Min. 20cm(Test Coin: US C50)

6.AUDIO FREQUENCY: 200Hz (Iron)
700Hz (Gold)
1200Hz (Silver)

7.TEMPERATURE RANGE:-20°C~60°C

8.SIZE:540mm(L) ×345mm(w) ×150mm(H)

9.GROSS WEIGHT:2.50 Kg

10.NET WEIGHT:1.10 Kg

To all residents of the European Union

Important environmental information about this product

This symbol on this unit or the package indicates that disposal of this unit after its lifecycle could harm the environment.

Do not dispose the unit (or batteries) as unsorted municipal waste: it should be brought to a specialized company for recycling. This unit should be returned to your distributor or to a local recycling service.

Respect the local environmental rules.

If in doubt, contact your local waste disposal authorities.

UNDERGROUND METAL DETECTOR



No:2013-9020C